

01

**TOILET PAPER
DISPENSERS**

we wrap you in confort



A modern bathroom with a white toilet, a window with plants, and a wall-mounted toilet paper dispenser. The room features light-colored wood paneling on the wall and a white tiled floor. A window on the left shows a view of trees and a small potted plant on the sill. Two white wall-mounted dispensers are visible above the toilet. A white toilet paper dispenser is mounted on the wall to the right of the toilet. A white toilet paper roll is visible on the floor in the foreground.

TOILET PAPER DISPENSERS

*For paper roll, standard roll
(2 or 3 units) or paper towels*

- Wide variety of toilet paper dispensers that are functional and straightforward to integrate into any toilet facility environment. Manufactured in various materials (steel, stainless steel, etc.) and in different finishes (white, black, bright, satin, etc.).
- Solutions that accept paper rolls of different diameters and different core sizes.
- They incorporate braking systems to optimise consumption
- Exterior sight glass for paper level
- Lock with special key for protection against vandalism

TOILET PAPER DISPENSERS

paper roll Ø 230 mm



PR2783

capacity: max. roll Ø230 mm

material: steel

finish: white epoxy



PR2783B

capacity: max. roll Ø230 mm

material: steel

finish: matte black epoxy



PR2783C

capacity: max. roll Ø230 mm

material: AISI 304 stainless steel

finish: bright



PR2783CS

capacity: max. roll Ø230 mm

material: AISI 304 stainless steel

finish: satin



PR2783 · PR2783B · PR2783C · PR2783CS COMPONENTS AND MATERIALS

- Stylish design suitable for every washroom
- One-piece body
- One-piece lid, which can be swung down for replenishment
- Backplate with multiple slots for easy installation
- Removable plastic shaft for standard Ø45 mm paper roll core with two different positions to allow different paper roll diameters (max. Ø230 mm)
- Shaft with inertial anti-spin retainer
- Slot at the front for viewing content level
- Backplate with an anti-moisture support
- Lock with standard Mediclinics key

PR2783 · PR2783B · PR2783C · PR2783CS TECHNICAL SPECIFICATIONS

Thickness of body and lid	0.8 mm
Weight (empty)	1.25 Kg
Paper roll capacity	max. Ø230 mm
Toilet roll width	max. 115 mm
Toilet roll core	min. Ø45 mm
Recommended installation height	65 - 75 cm at lower point
Installation height	70 cm at the lowest point

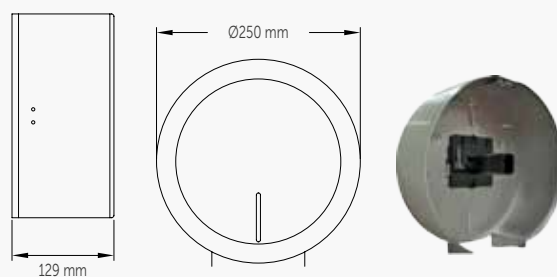

TOILET PAPER DISPENSERS

paper roll Ø 275 mm / 3 paper rolls



PR2787

capacity: max. roll Ø275 mm

material: steel

finish: white epoxy



PR2787B

capacity: max. roll Ø275 mm

material: steel

finish: matte black epoxy



PR2787C

capacity: max. roll Ø275 mm

material: AISI 304 stainless steel

finish: bright



PR2787CS

capacity: max. roll Ø275 mm

material: AISI 304 stainless steel

finish: satin

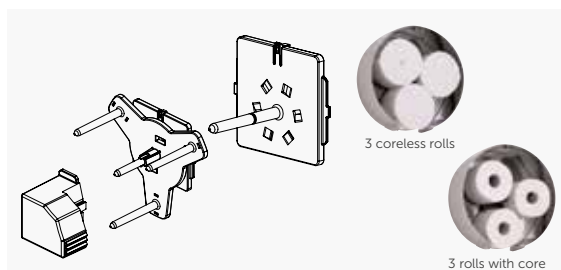

KIT 2789

optional shaft for 3 rolls

material: thermoplastic

finish: black

optional accessory available separately

PR2787 · PR2787B · PR2787C · PR2787CS COMPONENTS AND MATERIALS

- Stylish design suitable for every washroom
- One-piece body
- One-piece lid, which can be swung down for replenishment
- Backplate with multiple slots for easy installation
- Removable plastic shaft for standard Ø45 mm paper roll core with two different positions to allow different paper roll diameters (max. Ø275 mm)
- Shaft with inertial anti-spin retainer
- Slot at the front for viewing content level
- Backplate with anti-moisture support
- Lock with standard Mediclinics key

PR2787 · PR2787B · PR2787C · PR2787CS TECHNICAL SPECIFICATIONS

Thickness of body and lid	0.8 mm
Weight (empty)	1.70 Kg
Paper roll capacity	max. Ø275 mm
Toilet roll width	max. 115 mm
Toilet roll core	min. Ø45 mm
Recommended installation height	65 - 75 cm at lower point
Installation height	70 cm at lower point

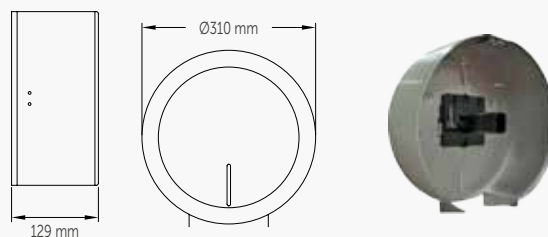

TOILET PAPER DISPENSERS

3 paper rolls / paper roll Ø 275 mm



PR0789

capacity: **3 rolls**

material: **steel**
finish: **white epoxy**



PR0789C

capacity: **3 rolls**

material: **AISI 304 stainless steel**
finish: **bright**



PR0789CS

capacity: **3 rolls**

material: **AISI 304 stainless steel**
finish: **satin**

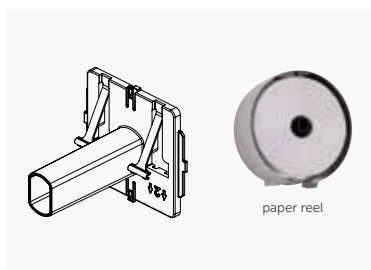

93910055MD

optional shaft for 1 roll

material: **thermoplastic**
finish: **black**

PR0789 · PR0789C · PR0789CS · 93910055MD COMPONENTS AND MATERIALS

PR0789 · PR0789C · PR0789CS

- One-piece body
- One-piece lid, which can be swung down for replenishment
- Backplate with an anti-moisture support
- Modular thermoplastic shaft allows three standard rolls to be fitted, core or coreless rolls
- The roll descends automatically once the previous one has been finished

- Slot at the front for viewing content level
- Lock with standard Mediclinics key

93910055MD

- Optional thermoplastic shaft for industrial roll with inertial anti-spin retainer to optimise dispensing of toilet paper. Replaces the original three standard roll shaft, allowing the use of industrial toilet rolls.

PR0789 · PR0789C · PR0789CS · 93910055MD TECHNICAL SPECIFICATIONS

PR0789 · PR0789C · PR0789CS

Thickness of body and lid	0.8 mm
Weight (empty)	1.75 Kg
Toilet roll width	max. 115 mm
Toilet paper roll capacity	3 u.
Toilet roll holder (optional shaft)	max. Ø275 mm
Toilet roll core	min. Ø45 mm
Recommended installation height	65 - 75 cm at lower point
Installation height	70 cm at lower point

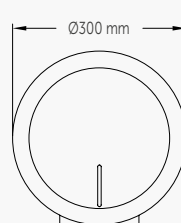
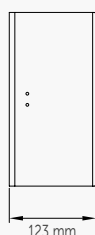

3 coreless rolls

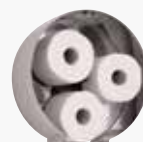

3 rolls with core

TOILET PAPER DISPENSERS

3 units paper rolls / 2 units paper rolls



PR0781

capacity: 3 rolls

material: steel

finish: white epoxy



PR0781C

capacity: 3 rolls

material: AISI 304 stainless steel

finish: bright



PR0781CS

capacity: 3 rolls

material: AISI 304 stainless steel

finish: satin



PR0700CS

capacity: 2 rolls

material: AISI 304 stainless steel

finish: satin



PR0781 · PR0781C · PR0781CS · PR0700CS COMPONENTS AND MATERIALS

• PR0781 · PR0781C · PR0781CS

- One-piece body
- One-piece, weld-free lid
- Two slots in both sides that indicate the content level
- The toilet paper roll descends when the previous one has been finished by simply putting the hand through the side slot
- Lock with standard Mediclinics key

• PR0700CS

- One-piece body
- Laser welded swung lid
- The roll descends automatically, once the previous one has been finished
- System for optimizing the issue of paper
- Anti-vandal key lock

PR0781 · PR0781C · PR0781CS · PR0700CS TECHNICAL SPECIFICATIONS

PR0781 · PR0781C · PR0781CS

Thickness of body and lid	0.8 mm
Weight (empty)	1.3 Kg
Toilet paper roll capacity	3 u.
Toilet paper roll	Ø105-125 mm
Recommended installation height	65 - 75 cm at lower point
Installation height	70 cm at lower point

PR0700CS

Thickness of body and lid	0.8 mm
Weight (empty)	2 Kg
Toilet paper roll capacity	2 u.
Toilet paper roll	max. Ø135 mm
Recommended installation height	65-75 at lower point
Installation height	70 cm at lower point

PR0781 / C / CS

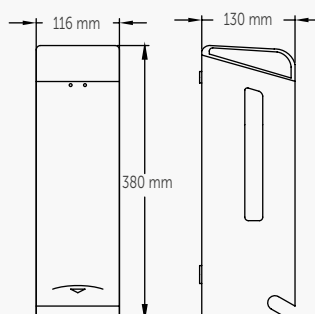

PR0700CS

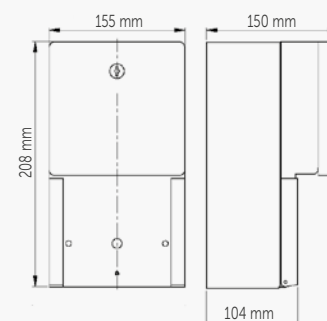

TOILET PAPER DISPENSERS

2 units paper rolls



PR2784

capacity: 2 rolls

material: **steel**

finish: **white epoxy**



PR2784B

capacity: 2 rolls

material: **steel**

finish: **matte black epoxy**



PR2784C

capacity: 2 rolls

material: **AISI 304 stainless steel**

finish: **bright**



PR2784CS

capacity: 2 rolls

material: **AISI 304 stainless steel**

finish: **satin**



PR2784 · PR2784B · PR2784C · PR2784CS COMPONENTS AND MATERIALS

- One-piece body
- One-piece, weld-free lid
- Two slots in both sides that indicate the content level
- Secondary paper roll bracket made in plastic allowing free movement of the roll in use. It can be set in two different positions, depending on the paper roll size
- The toilet paper roll descends when the previous one has been finished by simply putting the hand through the side slot
- Lock with standard Mediclinics key

PR2784 · PR2784B · PR2784C · PR2784CS TECHNICAL SPECIFICATIONS

Thickness of body and lid	0.8 mm
Weight (empty)	1.1 Kg
Toilet paper roll capacity	2 u.
Toilet paper roll	max. Ø130 mm
Recommended installation height	65 - 75 cm at lower point
Installation height	70 cm at lower point

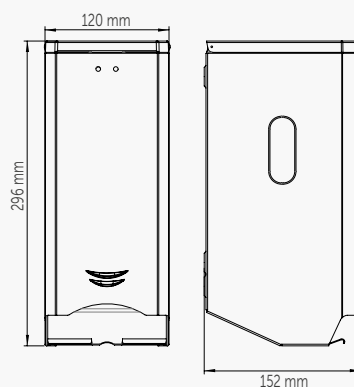

TOILET PAPER DISPENSERS

folded toilet tissue paper / seat covers



DTH100

capacity: 400 sheets (approx.)

material: **steel**

finish: **white epoxy**



DTH100C

capacity: 400 sheets (approx.)

material: **AISI 304 stainless steel**

finish: **bright**



DTH100CS

capacity: 400 sheets (approx.)

material: **AISI 304 stainless steel**

finish: **satin**



DCA100CS

capacity: 250 seat covers

material: **AISI 304 stainless steel**

finish: **satin**



DTH100 · DTH100C · DTH100CS · DCA100CS COMPONENTS AND MATERIALS

- One-piece body in AISI 304 stainless steel, with lid for refilling
- One-piece, weld-free lid
- Content viewer at the front
- Lock with standard Mediclinics key

DCA100CS

- One-piece, weld-free body
- Opening at the top to replace cover sheets box
- Easy pull opening system

DTH100 · DTH100C · DTH100CS · DCA100CS TECHNICAL SPECIFICATIONS

DTH100 · DTH100C · DTH100CS

DCA 100CS

DTH100 · DTH100C · DTH100CS

Body and lid thickness	0.8 mm
Towel capacity	400 (approx.)

DCA100CS

Body and lid thickness	0.8 mm
Seat cover capacity	250

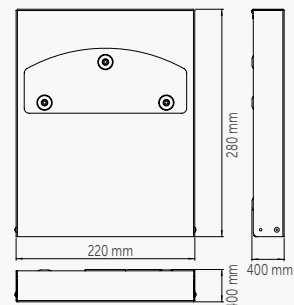
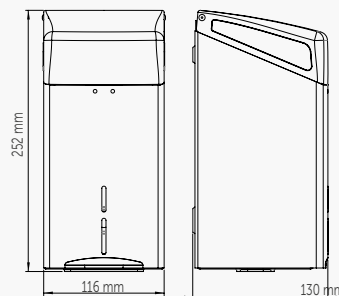

TOILET PAPER DISPENSERS

sanitary bag dispenser



DBH100
capacity: 50 bags (approx)
material: **steel**
finish: **white epoxy**



DBH100C
capacity: 50 bags (approx)
material: **AISI 304 stainless steel**
finish: **bright**



DBH100CS
capacity: 50 bags (approx)
material: **AISI 304 stainless steel**
finish: **satin**



AI0920C
sanitary bag dispenser
material: **AISI 304 stainless steel**
finish: **bright**

AI0920CS
sanitary bag dispenser
material: **AISI 304 stainless steel**
finish: **satin**



DBH100 · DBH100C · DBH100CS · AI0920C · AI0920CS COMPONENTS AND MATERIALS

DBH100 · DBH100C · DBH100CS

- One-piece body in AISI 304 stainless steel

AI0920C · AI0920CS

- Suitable for feminine sanitary bag refill boxes of 136 x 91 x 24 mm

DBH100 · DBH100C · DBH100CS · AI0920C · AI0920CS TECHNICAL SPECIFICATIONS

DBH100 · DBH100C · DBH100CS

Body thickness	0.8 mm
----------------	--------

AI0920C · AI0920CS

Body thickness	1 mm
----------------	------

DBH100 · DBH100C · DBH100CS

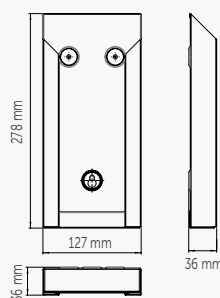

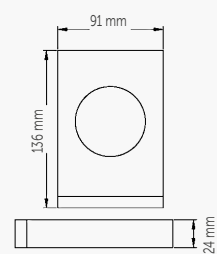

AI0920C · AI0920CS

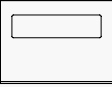

TOILET PAPER DISPENSERS

Table

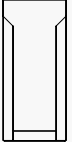
	MODEL	MATERIAL / FINISH				PAPER TYPE			
		Steel white epoxy	Steel matte black epoxy	AISI 304 Stainless steel bright	AISI 304 Stainless steel Satin	STANDARD		ROLL (INDUSTRIAL)	
						CAPACITY		CAPACITY	
						2 rolls	3 rolls	Ø230 mm	Ø275 mm
	PR2783	•					•		
	PR2783B		•				•		
	PR2783C			•			•		
	PR2783CS				•		•		
	PR2787	•						•	
	PR2787B		•					•	
	PR2787C			•				•	
	PR2787CS				•			•	
	PR0789	•				•		•	
	PR0789C			•		•		•	
	PR0789CS				•	•		•	
	PR0700CS				•				
	PR0781	•				•			
	PR0781C			•		•			
	PR0781CS				•	•			
	PR2784	•				•			
	PR2784B		•			•			
	PR2784C			•		•			
	PR2784CS				•	•			
	DCA100CS								
	DTH100	•							
	DTH100C			•					
	DTH100CS				•				
	DBH100	•							
	DBH100C			•					
	DBH100CS				•				
	AI0920C			•					
	AI0920CS				•				

TOILET PAPER DISPENSERS

Table

PAPER TYPE			SHAPE		LOCK WITH KEY	SUITABLE FOR					MODEL
Toilet seat cover	Sanitary towels	Sanitary Bags	Rectangular	Round		Gyms and Sport centers and similars	Hospitals and Health Centres facilities edery care homes and similars	Hotels and other accommo-dation	Offices, official or-ganizations, schools and similars	Airports, shopping malls and similars	
				•	•		•	•	•		PR2783
				•			•	•	•		PR2783B
				•	•	•	•	•	•		PR2783C
				•	•	•	•	•	•		PR2783CS
				•	•		•	•	•	•	PR2787
				•			•	•	•	•	PR2787B
				•	•	•	•	•	•	•	PR2787C
				•	•	•	•	•	•	•	PR2787CS
				•	•		•	•	•		PR0789
				•	•	•	•	•	•		PR0789C
				•	•	•	•	•	•		PR0789CS
			•		•	•	•	•	•		PR0700CS
			•		•		•	•	•		PR0781
			•		•	•	•	•	•		PR0781C
			•		•	•	•	•	•		PR0781CS
			•		•		•	•	•		PR2784
			•		•		•	•	•		PR2784B
			•		•	•	•	•	•		PR2784C
			•		•	•	•	•	•		PR2784CS
•			•			•	•	•	•	•	DCA100CS
	•		•		•		•	•	•		DTH100
	•		•		•	•	•	•	•		DTH100C
	•		•		•	•	•	•	•		DTH100CS
		•	•				•	•	•	•	DBH100
		•	•				•	•	•	•	DBH100C
		•	•				•	•	•	•	DBH100CS
		•	•					•	•	•	AI0920C
		•	•					•	•	•	AI0920CS